

Track and Slide System

BEFORE ORDERING - MEASURING YOUR MAST

PROFILE VARIATIONS

Before placing your order, you will have to determine the size and shape of your mast's luff groove. If you have an external track on your boat now, Tides will need the width of this external track.

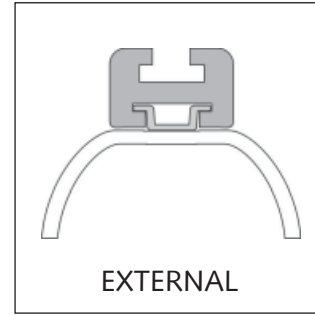
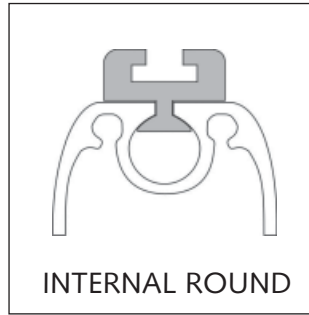
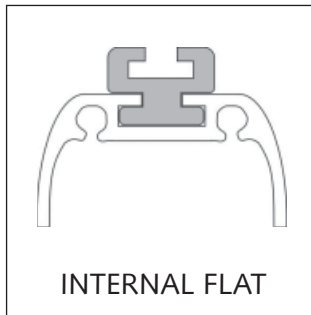

MEASUREMENT DISKS

To help measure the luff groove on your mast, Tides will provide you with a set of 5 blue measurement disks (pictured below).



Lettered Disks

are used to measure the luff groove width on both Internal - Flat and Internal - Round spars.

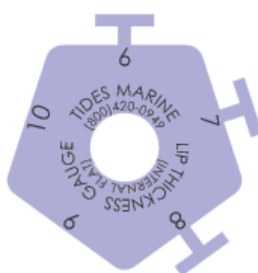

Numbered Disks

from 1 through 8 are used to measure the luff groove's lip thickness on Internal - Flat luff grooves. Information about flat internal luff grooves can be found on pages 5 through 8.



The Numbered Disk 11 through 17

is used to measure the luff groove's lip thickness on Internal - Round luff grooves. Information about round internal luff grooves can be found on pages 9 through 12.

Luff Groove Width

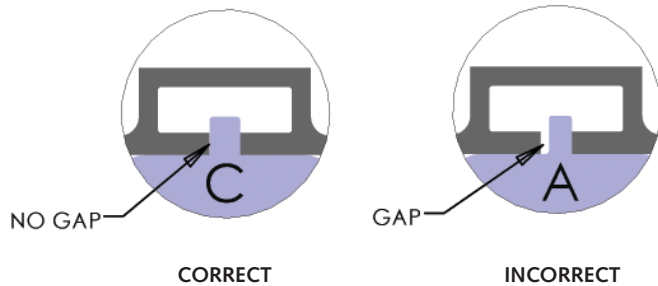

STEP 1.

Using the lettered disks, determine the width of the luff groove. Simply insert the lettered studs into the luff groove anywhere along the mast. Select the stud which fits in the luff groove with the least amount of play side-to-side without jamming or sticking.

Once you have found the stud size that fits snugly, move the stud up the mast (within the luff groove) as far as you can reach to ensure that the luff groove width is uniform.

Enter this letter on the Internal Luff Groove Order Form - Line A.

Luff Groove Lip Thickness

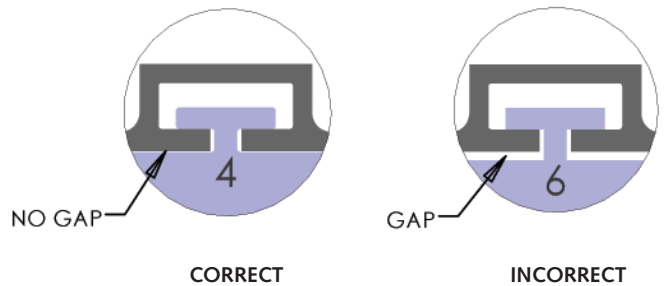

STEP 2.

Next, use the numbered disks (1 through 8) to determine the lip thickness of the luff groove. Select the stud which allows the least amount of play fore-and-aft. You can slide these numbered studs through the mast gate. Or, you can turn each stud 90°, insert it into the luff groove above or below the mast gate and turn the stud until you find the one that fits snugly.

Enter this letter on the Internal Luff Groove Order Form - Line B.

INTERNAL LUFF GROOVE - FLAT - Available Sizes

STEP 3.

When you have measured your luff groove width and lip thickness, use the table below to determine if Tides can cut a track that matches your measurements. Each box with a "✓" indicates that Tides can produce track to fit your mast.

Lip Thickness	Slot Widths																	
	A	B	C	D	E	F	G	H	I	J	K	L	M	N	O	P	Q	R
1									✓	✓	✓	✓						
2							✓	✓	✓	✓	✓	✓	✓	✓				
3	✓	✓	✓	✓	✓	✓	✓	✓	✓	✓	✓	✓	✓	✓	✓	✓	✓	✓
4	✓	✓	✓	✓	✓	✓	✓	✓	✓	✓	✓	✓	✓	✓	✓	✓	✓	✓
5	✓	✓	✓	✓	✓	✓	✓	✓	✓	✓	✓	✓	✓	✓	✓	✓	✓	✓
6	✓	✓	✓	✓	✓	✓	✓	✓	✓	✓	✓	✓	✓	✓	✓	✓	✓	✓
7	✓	✓	✓	✓	✓	✓	✓	✓	✓	✓	✓	✓	✓	✓	✓	✓	✓	✓
8	✓	✓	✓	✓	✓	✓	✓	✓	✓	✓	✓	✓	✓	✓	✓	✓	✓	✓

MAST GATE – Size and Location

Measure the length of your existing mast gate (D in the diagram to the right).

In order to install the Tides Track, the mast gate must be at least 3” long and open on both sides of the centerline of the luff groove.

The distance from the top of the mast gate to the gooseneck should be at least 10” long (E in the diagram to the right). If the distance is less you might not be able to feed the Tides Track past the gooseneck and into the luff groove.

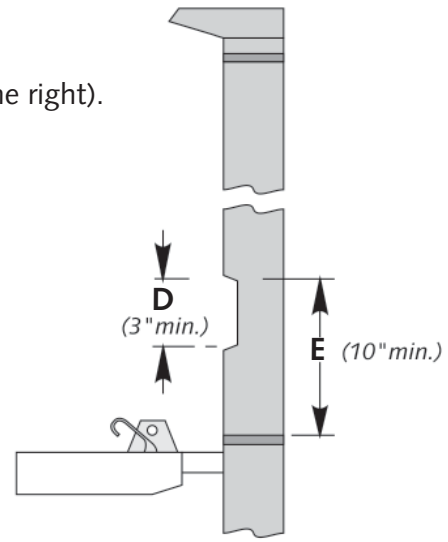

! NOTE:
Both of these measurements are critical to the installation of the Tides Track.

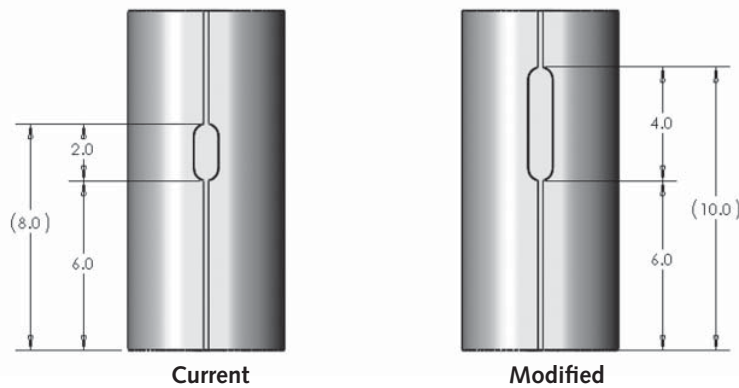

If your current mast gate configuration does not meet the above parameters, you will have to modify your existing mast gate accordingly.

In the above example, the existing mast gate is 2” long (too short) and the distance from the top of the mast gate to the gooseneck is 6” (also too short).

Simply enlarge the mast gate using a Dremel tool or grinder, moving up the mast until the top of the mast gate is 10” above the gooseneck.

Your mast gate is now 4” long.

Record this measurement on the Internal Luff Groove Order Form - Line C.

The distance from the top of the mast gate to the gooseneck is now 10” long.

Record this measurement on the Internal Luff Groove Order Form - Line D.

OVERALL TRACK LENGTH

Next, measure the overall length of Tides Track you want to install on your vessel. The track should start approximately 2" below the halyard sheave and stop 1" – 2" above the gooseneck. Your measurement will be more accurate if you first identify the distance from the top of your halyard thimble to the shackle pin – the halyard hardware (see photo below). Then, connect the end of a tape measure to the pin in your halyard shackle along with a retrieval line.

Hoist the halyard as far as it will go and measure to the point on the mast where you want the Tides Track to end. Adjust this measurement to account for the length of your halyard hardware.

In this example, the halyard hardware is 3" long. If you add 1" to the overall measurement on your tape, the track should stop 2" below the masthead sheave.

! NOTE:
It is a good idea to attach a small diameter retrieval line to the end of the halyard to aid in retrieving the tape from the masthead.

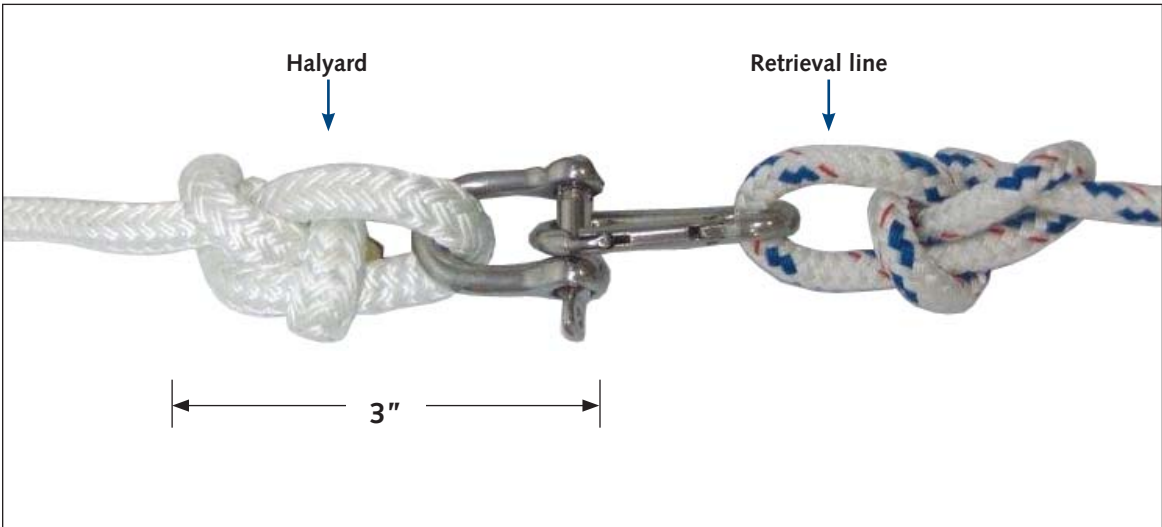

Record this measurement on the Internal Luff Groove Order Form - Line E.

INTERNAL WIDTH OF EXISTING LUFF GROOVE

Tides prefers to maximize the width of the track shape that enters the luff groove, whether the luff groove has an internal flat shape or internal round shape. If Tides can maximize the amount of UHMW material that goes into the luff groove, the track will perform better when the slides/sail begin to load the track assembly during vessel operation.

Measure the internal width of your luff groove (flat or round) **at the mast gate** using a tape measure / caliper / etc. In most cases, you can get a fairly accurate measurement of this space by simply measuring the width of the mast gate. This should be satisfactory. See photos below.

Record this measurement on the Internal Luff Groove Order Form - Line F.



Luff Groove Width

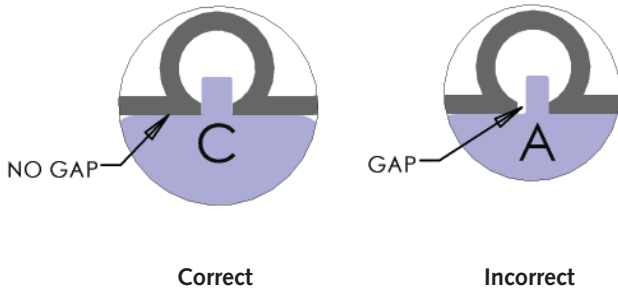

STEP 1.

Using the lettered disks, determine the width of your luff groove. Simply insert the numbered studs into the luff groove anywhere along the mast. Select the stud which fits in the luff groove with the least amount of play side-to-side.

Once you have found the stud size that fits snugly, move the stud up the mast (within the luff groove) as far as you can reach to ensure that the luff groove width is uniform.

Enter this letter on the Internal Luff Groove Order Form - Line A.

Luff Groove Lip Thickness

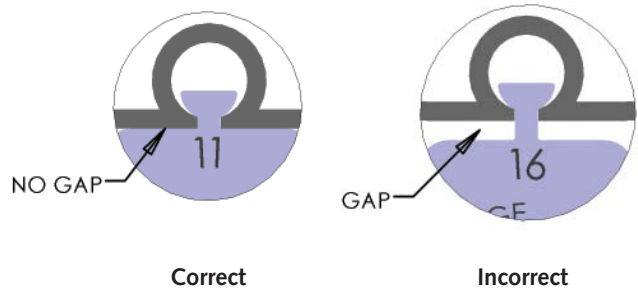

STEP 2.

Next, use the numbered disks (11 through 17) to determine the lip thickness of the luff groove. Select the stud which allows the least amount of play fore-and-aft. You can slide these numbered studs through the mast gate. Or, you can turn each stud 90°, insert it into the luff groove above or below the mast gate and turn the stud until you find the one that fits snugly.

Enter this letter on the Internal Luff Groove Order Form - Line B.

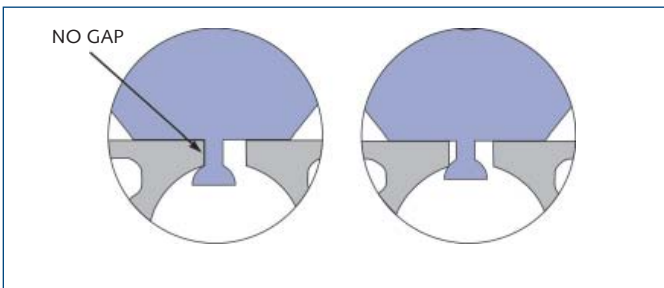

CAUTION: When measuring the lip thickness of luff grooves with an internal round shape, be sure the numbered stud is in contact with the luff groove lip as shown left. There should be no gaps between the stud and the lip.

INTERNAL LUFF GROOVE - ROUND - Available Sizes

STEP 3.

When you have measured your luff groove width and lip thickness, use the table to determine if Tides can cut a track that matches your measurements. Each box with a “√” indicates that Tides can produce track to fit your mast.

Lip Thickness	Slot Widths					
	A	B	C	D	E	F
11	√	√	√	√	√	√
12	√	√	√	√	√	√
13	√	√	√	√	√	√
14	√	√	√	√	√	√
15	√	√	√	√	√	√
16	√	√	√	√	√	√
17	√	√	√	√	√	√

MAST GATE – Size and Location

Measure the length of your existing mast gate (D in the diagram to the right).

In order to install the Tides Track, the mast gate must be at least 3" long and open on both sides of the centerline of the luff groove.

The distance from the top of the mast gate to the gooseneck should be at least 10" long (E in the diagram to the right). If the distance is less you might not be able to feed the Tides Track past the gooseneck and into the luff groove.

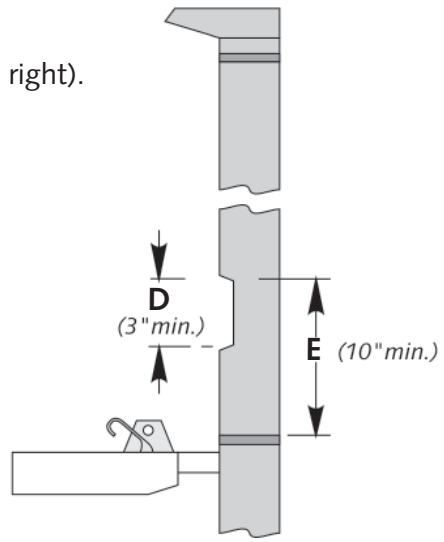

! NOTE:
Both of these measurements are critical to the installation of the Tides Track.

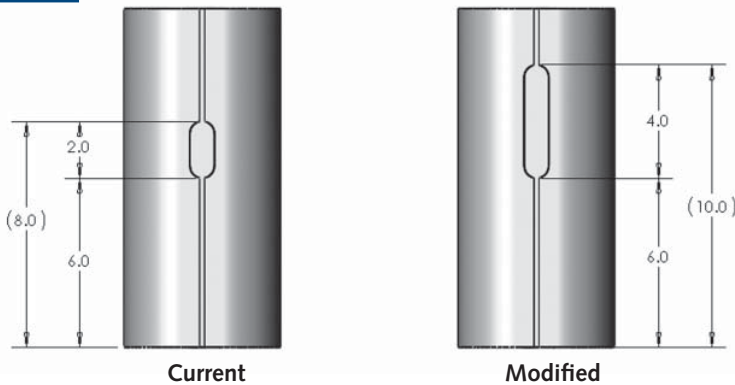

If your current mast gate configuration does not meet the above parameters, you will have to modify your existing mast gate accordingly.

In the above example, the existing mast gate is 2" long (too short) and the distance from the top of the mast gate to the gooseneck is 6" (also too short).

Simply enlarge the mast gate using a Dremel tool or grinder, moving up the mast until the top of the mast gate is 10" above the gooseneck.

Your mast gate is now 4" long.

Record this measurement on the Internal Luff Groove Order Form - Line C.

The distance from the top of the mast gate to the gooseneck is now 10" long.

Record this measurement on the Internal Luff Groove Order Form - Line D.

OVERALL TRACK LENGTH

Next, measure the overall length of Tides Track you want to install on your vessel. The track should start approximately 2" below the halyard sheave and stop 1" – 2" above the gooseneck. Your measurement will be more accurate if you first identify the distance from the top of your halyard thimble to the shackle pin – the halyard hardware (see photo below). Then, connect the end of a tape measure to the pin in your halyard shackle along with a retrieval line.

Hoist the halyard as far as it will go and measure to the point on the mast where you want the Tides Track to end. Adjust this measurement to account for the length of your halyard hardware.

In this example, the halyard hardware is 3" long. If you add 1" to the overall measurement on your tape, the track should stop 2" below the masthead sheave.

! NOTE:

It is a good idea to attach a small diameter retrieval line to the end of the halyard to aid in retrieving the tape from the masthead.

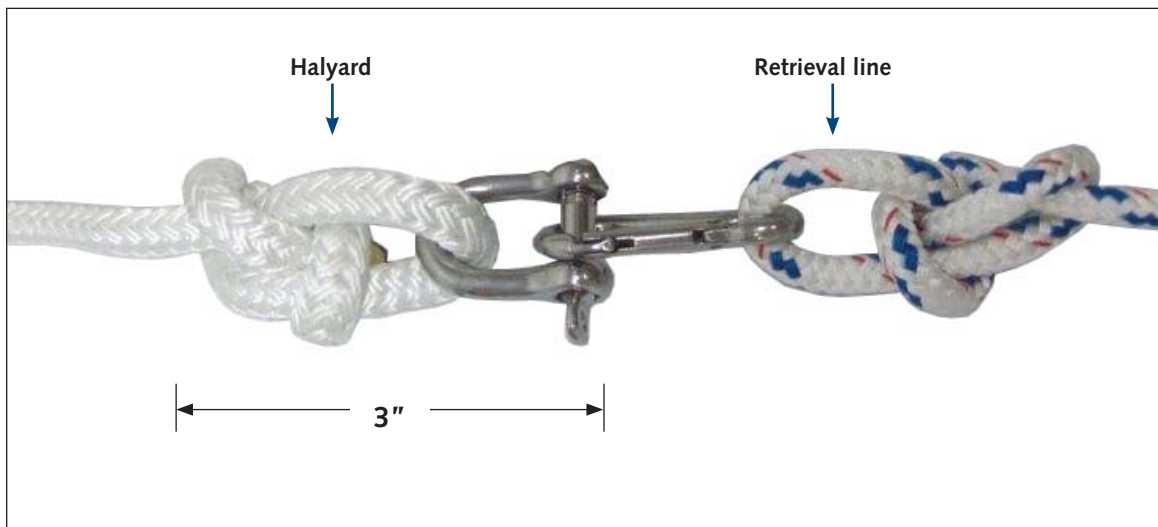

Record this measurement on the Internal Luff Groove Order Form - Line E.

INTERNAL WIDTH OF EXISTING LUFF GROOVE

Tides prefers to maximize the width of the track shape that enters the luff groove, whether the luff groove has an internal flat shape or internal round shape. If Tides can maximize the amount UHMW material that goes into the luff groove, the better the track will perform when the slides / sail begin to load the track assembly during vessel operation.

Measure the internal width of your luff groove (flat or round) **at the mast gate** using a tape measure / caliper / etc. In most cases, you can get a fairly accurate measurement of this space by simply measuring the width of your mast gate. This should be satisfactory. See photos below.

Record this measurement on the Internal Luff Groove Order Form - Line G.



EXTERNAL TRACK WIDTH

Simply measure the distance from edge to edge of the existing external track. The most common track widths are 5/8", 7/8" and 1". If your track measures 1", Tides will need to see a sample of the existing track before producing a Tides Track for your boat. Cut a 1 1/2" piece of your track from the bottom of the track on your boat and send it to Tides Marine. Tides will measure the track width - cut a corresponding sample piece of Tides Track - and send it to you to test over the length of track on your boat.

If your track does not match the 5/8" or 7/8" standards, follow the same steps as noted above.

Record this measurement on the External Track Order Form - Line A.



EXTERNAL TRACK LENGTH

Please refer to the OVERALL TRACK LENGTH section on page 11 and measure the length of Tides Track you will want to install on your vessel.

Record this measurement on the External Track Order Form - Line B.

CMPE TRACK LENGTH

A Tides Marine Sailtrack System can be attached to bare composite spars, wood spars and aluminum spars with no luff groove.

Based upon the length of track you order, Tides will provide you with a number of "CMPE Fasteners" (see below) which are used to complete the installation.

Simply snap a chalk line from the masthead to the gooseneck down the center of the back of the mast. Then refer to the OVERALL TRACK LENGTH section on page 11 and measure the length of Tides Track you want to install on your vessel.



Record this measurement on the CMPE Track Order Form - Line A.

Record the number of reef points you have on your sail on the CMPE Track Order Form - Line B.